



# 10 dB Stripline Directional Coupler

REV2010.A

## MODEL C-0520-10

### OUTLINE DRAWING

UNIT: INCH

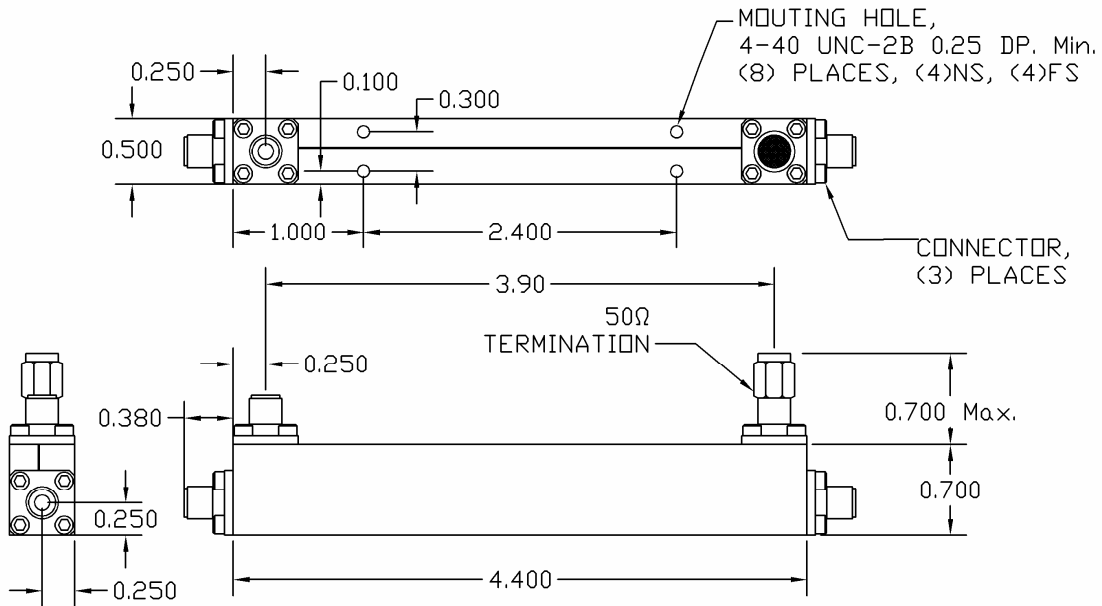

<b>ELECTRICAL SPECIFICATIONS</b>	<b>FREQUENCY RANGE</b>	<b>0.5-20.0</b>	<b>GHz</b>
	<b>NOMINAL COUPLING</b>	<b>10.0±0.5</b>	<b>dB</b>
	<b>FREQUENCY SENSITIVITY</b>	<b>±0.8</b>	<b>dB</b>
	<b>INPUT/OUTPUT PORT VSWR</b>	<b>Max. 1.35:1</b>	
	<b>COUPLED PORT VSWR</b>	<b>Max. 1.35:1</b>	
	<b>INSERTION LOSS</b>	<b>Max. 1.70</b>	<b>dB</b>
	<b>DIRECTIVITY</b>	<b>Min. 16.0</b>	<b>dB</b>
	<b>POWER RATING</b>	<b>Avg. 20.0</b>	<b>W</b>
		<b>Peak 3.0</b>	<b>kW</b>
	<b>PHYSICAL SPECIFICATIONS</b>	<b>CONNECTOR TYPE</b>	<b>SMA Female</b>
<b>WEIGHT</b>		<b>Max. 3.0</b>	<b>OZ</b>
<b>OPERATIONAL TEMP.</b>		<b>- 32 to + 85 °C</b>	



**Electromagnetic Technologies Industries, Inc. (ET Industries)**  
 50 Intervale Road, Boonton, NJ, 07005, USA E-Mail: sales@etiworld.com  
 Phone: 001+(973)-394-1719 Fax: 001+(973)394-1710 www.etiworld.com