



10 dB Stripline Directional Coupler

REV2010.A

MODEL C-0526-10

OUTLINE DRAWING

UNIT: INCH

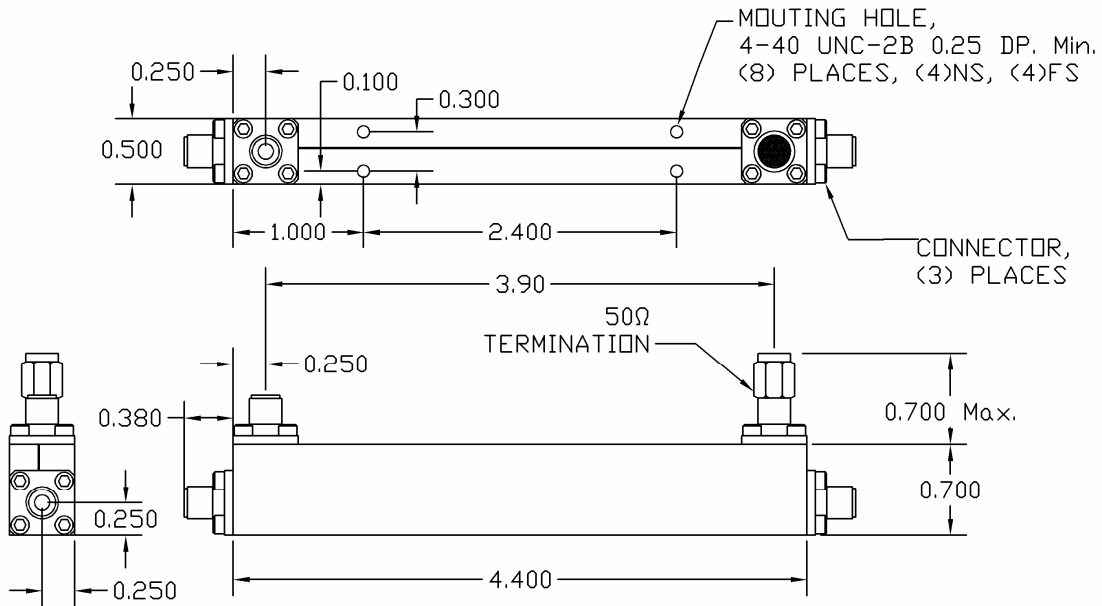

ELECTRICAL SPECIFICATIONS	FREQUENCY RANGE	0.5-26.5	GHz	
	NOMINAL COUPLING	10.0 ± 1.0	dB	
	FREQUENCY SENSITIVITY	± 1.00	dB	
	INPUT/OUTPUT PORT VSWR	Max. 1.40:1		
	COUPLED PORT VSWR	Max. 1.40:1		
	INSERTION LOSS	Max. 2.20	dB	
	DIRECTIVITY	Min. 14.0	dB	
	POWER RATING	Avg.	20.0	W
		Peak	3.0	kW
	PHYSICAL SPECIFICATIONS	CONNECTOR TYPE	SMA Female	
WEIGHT		Max. 3.0	OZ	
OPERATIONAL TEMP.		- 32 to + 85 °C		



Electromagnetic Technologies Industries, Inc. (ET Industries)
 50 Intervale Road, Boonton, NJ, 07005, USA E-Mail: sales@etiworld.com
 Phone: 001+(973)-394-1719 Fax: 001+(973)394-1710 www.etiworld.com