



10 dB Stripline Directional Coupler

REV2011.A

MODEL C-1826-10

OUTLINE DRAWING

UNIT: INCH

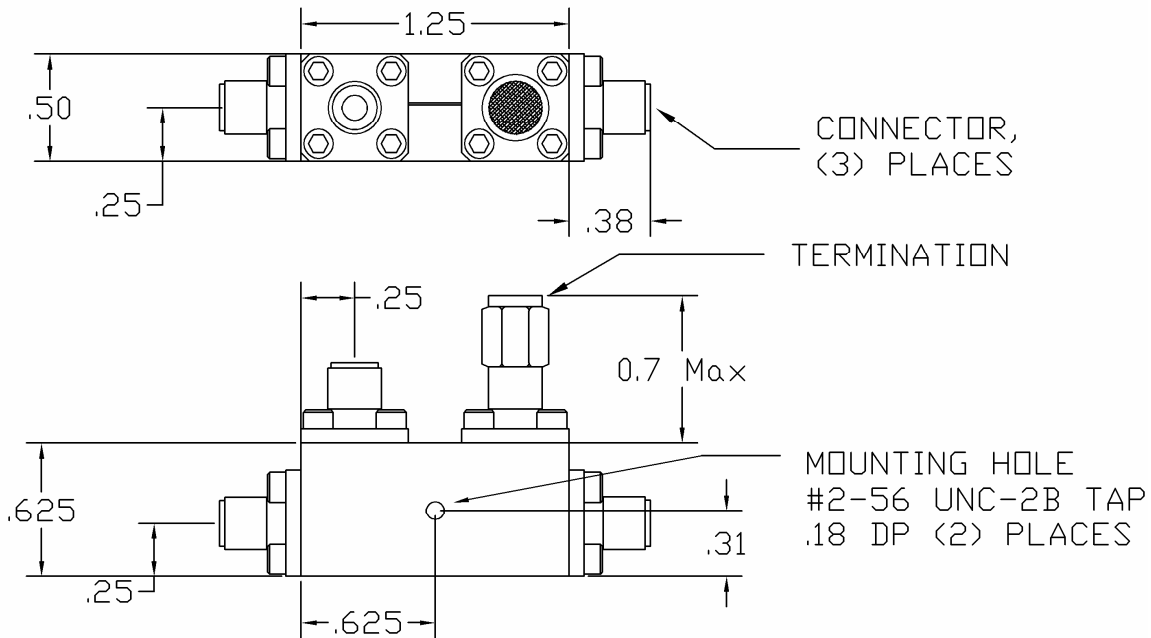

ELECTRICAL SPECIFICATIONS		FREQUENCY RANGE	18.0-26.5	GHz
		NOMINAL COUPLING	10.0±0.7	dB
		FREQUENCY SENSITIVITY	±0.30	dB
	INPUT/OUTPUT PORT VSWR	Max.	1.40:1	
	COUPLED PORT VSWR	Max.	1.40:1	
	INSERTION LOSS	Max.	1.30	dB
	DIRECTIVITY	Min.	15.0	dB
	POWER RATING	Avg.	20.0	W
		Peak	2.0	kW
PHYSICAL SPECIFICATIONS		CONNECTOR TYPE	SMA Female	
	WEIGHT	Max.	1.20	OZ
	OPERATIONAL TEMP.		- 32 to + 85 °C	



Electromagnetic Technologies Industries, Inc. (ET Industries)
 50 Intervale Road, Boonton, NJ, 07005, USA E-Mail: sales@etiworld.com
 Phone: 001+(973)-394-1719 Fax: 001+(973)394-1710 www.etiworld.com