



10 dB Stripline Directional Coupler

REV2010.A

MODEL C-220-10

OUTLINE DRAWING

UNIT: INCH

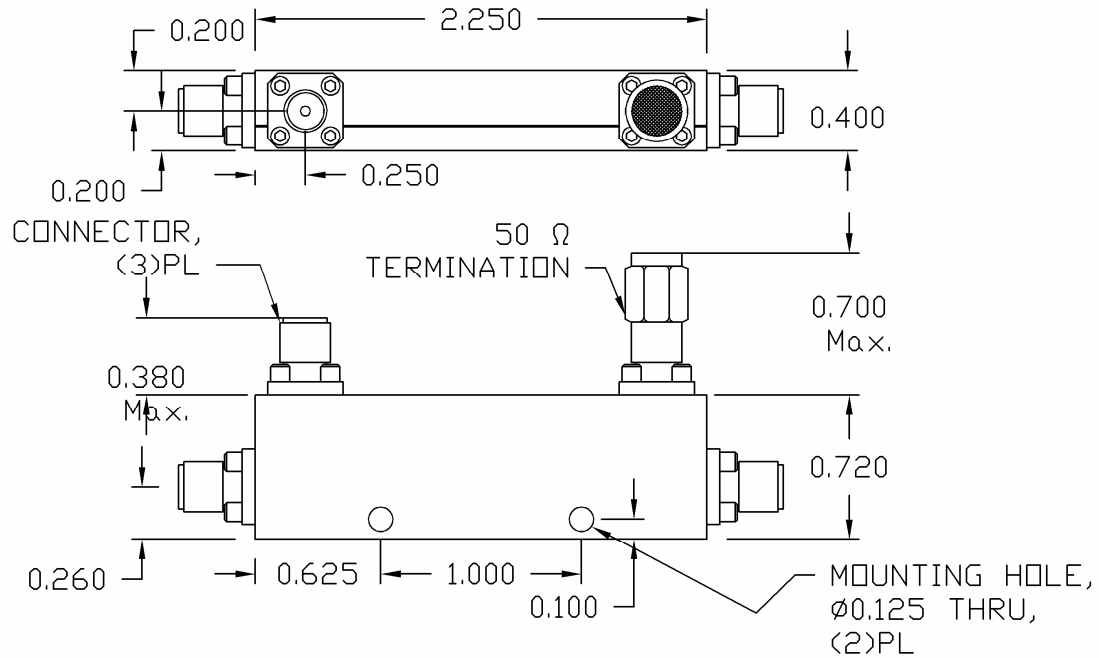

ELECTRICAL SPECIFICATIONS	FREQUENCY RANGE	2.0-20.0	GHz
	NOMINAL COUPLING	10.0±0.5	dB
	FREQUENCY SENSITIVITY	±0.30	dB
	INPUT/OUTPUT PORT VSWR	Max. 1.35:1	
	COUPLED PORT VSWR	Max. 1.35:1	
	INSERTION LOSS	Max. 1.35	dB
	DIRECTIVITY	Min. 15.0	dB
	POWER RATING	Avg. 20.0	W
		Peak 3.0	kW
	PHYSICAL SPECIFICATIONS	CONNECTOR TYPE	SMA Female
WEIGHT		Max. 1.42	OZ
OPERATIONAL TEMP.		- 32 to + 85 °C	



Electromagnetic Technologies Industries, Inc. (ET Industries)
 50 Intervale Road, Boonton, NJ, 07005, USA E-Mail: sales@etiworld.com
 Phone: 001+(973)-394-1719 Fax: 001+(973)394-1710 www.etiworld.com