



16 dB Stripline Directional Coupler

REV2010.A

MODEL C-226-16

OUTLINE DRAWING

UNIT: INCH

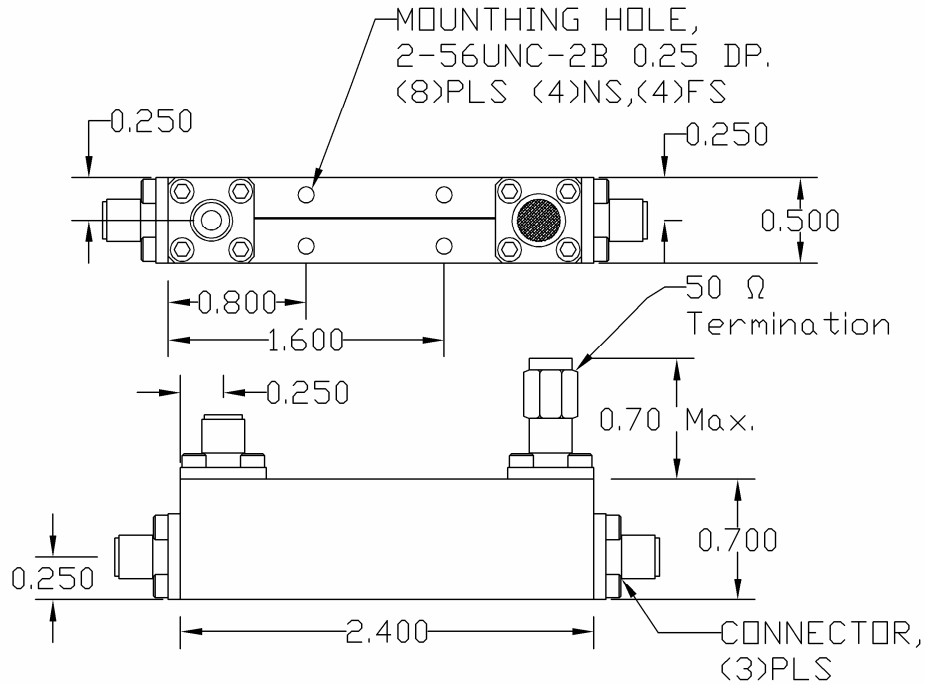

ELECTRICAL SPECIFICATIONS	FREQUENCY RANGE	2.0-26.5	GHz	
	NOMINAL COUPLING	16.0±0.6	dB	
	FREQUENCY SENSITIVITY	±0.60	dB	
	INPUT/OUTPUT PORT VSWR	Max. 1.50:1		
	COUPLED PORT VSWR	Max. 1.50:1		
	INSERTION LOSS	Max. 1.10	dB	
	DIRECTIVITY	Min. 13.0	dB	
	POWER RATING	Avg.	20.0	W
		Peak	3.0	kW
PHYSICAL SPECIFICATIONS	CONNECTOR TYPE	SMA Female		
	WEIGHT	Max. 1.85	OZ	
	OPERATIONAL TEMP.	- 32 to + 85 °C		



Electromagnetic Technologies Industries, Inc. (ET Industries)
 50 Intervale Road, Boonton, NJ, 07005, USA E-Mail: sales@etiworld.com
 Phone: 001+(973)-394-1719 Fax: 001+(973)394-1710 www.etiworld.com