



30 dB Stripline Directional Coupler

MODEL C-2650-30

OUTLINE DRAWING

UNIT: INCH

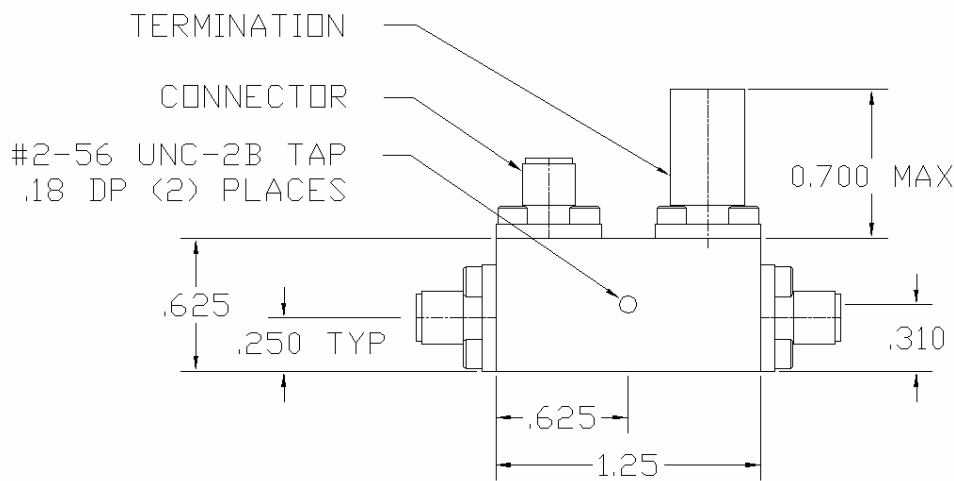
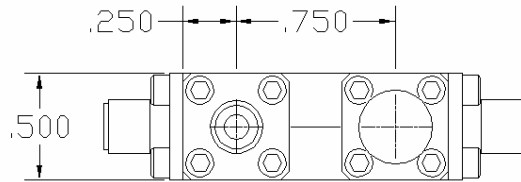

ELECTRICAL SPECIFICATIONS	FREQUENCY RANGE	26.5-50.0	GHz
	NOMINAL COUPLING	30.0±1.0	dB
	FREQUENCY SENSITIVITY	±0.70	dB
	INPUT/OUTPUT PORT VSWR	Max. 1.80:1	
	COUPLED PORT VSWR	Max. 1.80:1	
	INSERTION LOSS	Max. 1.60	dB
	DIRECTIVITY	Min. 10.0	dB
	POWER RATING	Avg. 16.0	W
		Peak 3.0	kW
	PHYSICAL SPECIFICATIONS	CONNECTOR TYPE	2.4mm Female
WEIGHT		Max. 1.18	OZ
OPERATIONAL TEMP.		- 32 to + 85 °C	

