



2-Way Stripline Power Divider

REV2010.A

MODEL D-1865-2

OUTLINE DRAWING

UNIT: INCH

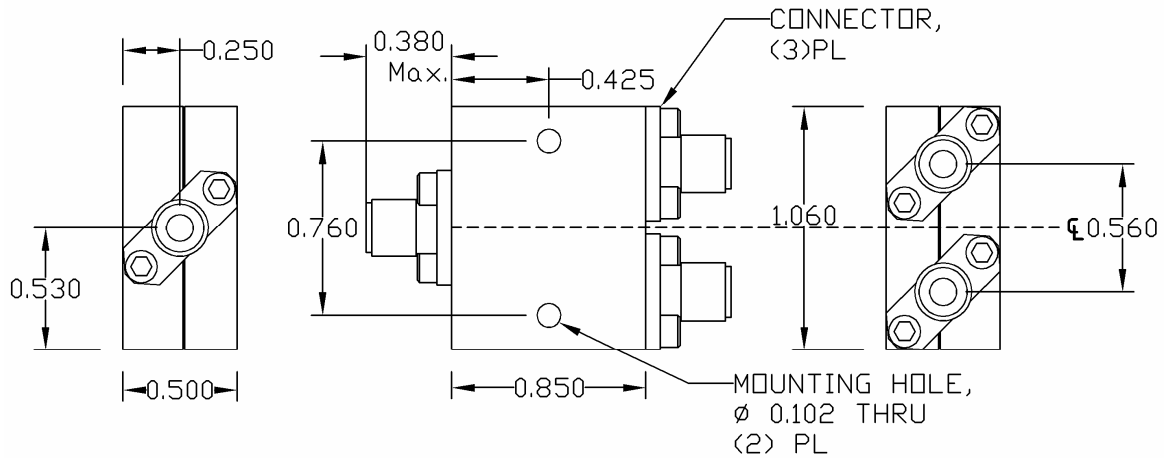

ELECTRICAL SPECIFICATIONS		FREQUENCY RANGE	18.0-65.0	GHz
	INPUT VSWR	Max.	1.80:1	
	OUTPUT VSWR	Max.	1.80:1	
	AMPLITUDE BALANCE	Max.	0.60	dB
	PHASE BALANCE	Max.	5.0	Deg.
	INSERTION LOSS	Max.	2.00	dB
	ISOLATION	Min.	20.0	dB
	POWER RATING	Avg.	10.0	W
		Peak	1.0	kW
PHYSICAL SPECIFICATIONS		CONNECTOR TYPE	1.85mm (V) Female	
	WEIGHT	Max.	1.20	Oz
	OPERATIONAL TEMP.		- 32 to + 85 °C	



Electromagnetic Technologies Industries, Inc. (ET Industries)
 50 Intervale Road, Boonton, NJ, 07005, USA E-Mail: sales@etiworld.com
 Phone: 001+(973)-394-1719 Fax: 001+(973)394-1710 www.etiworld.com