



90-Degree 3dB Stripline Hybrid Coupler

REV2010.A

MODEL Q-24-90

OUTLINE DRAWING

UNIT: INCH

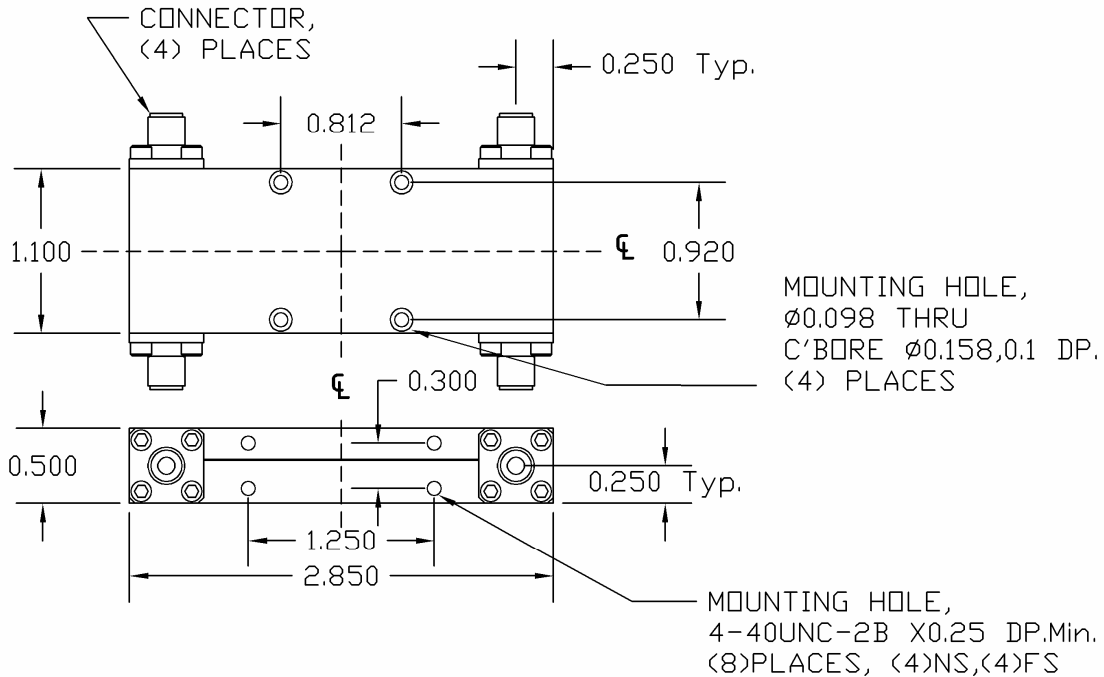

ELECTRICAL SPECIFICATIONS	FREQUENCY RANGE		2.0-4.0	GHz
		COUPLING	Typ.	3.0
	VSWR	Max.	1.20:1	
	AMPLITUDE BALANCE		\pm 0.25	dB
	PHASE BALANCE		\pm 3.0	Deg.
	INSERTION LOSS	Max.	0.60	dB
	ISOLATION	Min.	22.0	dB
	POWER RATING	Avg.	20.0	W
		Peak	3.0	kW
PHYSICAL SPECIFICATIONS	CONNECTOR TYPE		SMA Female	
	WEIGHT	Max.	2.90	Oz
	OPERATIONAL TEMP.		- 32 to + 85 °C	



Electromagnetic Technologies Industries, Inc (ET Industries)
 50 Intervale Road, Boonton, NJ, 07005, USA E-Mail: sales@etiworld.com
 Phone: 001+(973)-394-1719 Fax: 001+(973)394-1710 www.etiworld.com