



10 dB Stripline Directional Coupler

MODEL C-2650-10

OUTLINE DRAWING

UNIT: INCH

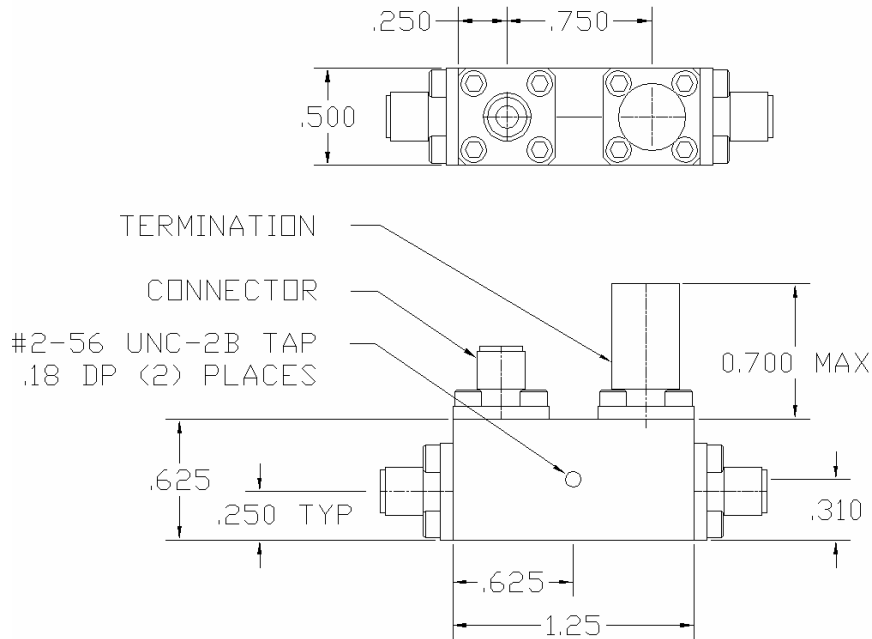

ELECTRICAL SPECIFICATIONS		FREQUENCY RANGE	26.5-50.0	GHz
		NOMINAL COUPLING	10.0 ± 1.0	dB
		FREQUENCY SENSITIVITY	± 1.0	dB
		INPUT/OUTPUT PORT VSWR	Max. 1.80:1	
		COUPLED PORT VSWR	Max. 1.80:1	
		INSERTION LOSS	Max. 2.30	dB
		DIRECTIVITY	Min. 10.0	dB
		POWER RATING	Avg. 16.0	W
			Peak 3.0	kW
PHYSICAL SPECIFICATIONS		CONNECTOR TYPE	2.4mm Female	
		WEIGHT	Max. 1.20	OZ
		OPERATIONAL TEMP.	- 32 to + 85 °C	



Electromagnetic Technologies Industries, Inc. (ET Industries)
 50 Intervale Road, Boonton, NJ, 07005, USA E-Mail: sales@etiworld.com
 Phone: 001+(973)-394-1719 Fax: 001+(973)394-1710 www.etiworld.com